

**Part Number: 08171-47800**

**Kit Contents**

Item #	Quantity Reqd.	Description
1	1	Ashtray
2	1	Installation Manual

**Hardware Bag Contents**

Item #	Quantity Reqd.	Description
1		
2		
3		

**Additional Items Required For Installation**

Item #	Quantity Reqd.	Description
1		
2		
3		

**Conflicts**

--

**Recommended Tools**

<b>Personal &amp; Vehicle Protection</b>	<b>Notes</b>
None	
<b>Special Tools</b>	<b>Notes</b>
None	
<b>Installation Tools</b>	<b>Notes</b>
None	
<b>Special Chemicals</b>	<b>Notes</b>
None	

**Recommended Sequence of Application**

Item #	Accessory
1	
2	
3	

\*Mandatory







**General Applicability**

IS 250	2014
IS 350	2014
IS Convertible	2014
IS-F	2014

**Vehicle Service Parts** (may be required for reassembly)

Item #	Quantity Reqd.	Description
1		
2		
3		

**Legend**

	<b>STOP:</b> Damage to the vehicle may occur. Do not proceed until process has been complied with.
	<b>OPERATOR SAFETY:</b> Use caution to avoid risk of injury.
	<b>CAUTION:</b> A process that must be carefully observed in order to reduce the risk of damage to the accessory/vehicle and to ensure a quality installation.
	<b>TOOLS &amp; EQUIPMENT:</b> Used in Figures calls out the specific tools and equipment recommended for this process.
	<b>REVISION MARK:</b> This mark highlights a change in installation with respect to previous issue.
	<b>SAFETY TORQUE:</b> This mark indicates that torque is related to safety.

Care must be taken when installing this accessory to ensure damage does not occur to the vehicle. The installation of this accessory should follow approved guidelines to ensure a quality installation.

These guidelines can be found in the "Accessory Installation Practices" document.

This document covers such items as:-

- Vehicle Protection (use of covers and blankets, cleaning chemicals, etc.).
- Safety (eye protection, rechecking torque procedure, etc.).
- Vehicle Disassembly/Reassembly (panel removal, part storage, etc.).
- Electrical Component Disassembly/Reassembly (battery disconnection, connector removal, etc.).

Please see your Toyota dealer for a copy of this document.



Fig. 1-1

- ⚠ 1. CAUTION: The Ashtray comes with a rubber jacket. The rubber jacket must be used whenever possible to provide the tightest fit. If the Ashtray cannot fit into the cup holder, remove the rubber jacket and store in a safe place. (Fig. 1-1)**

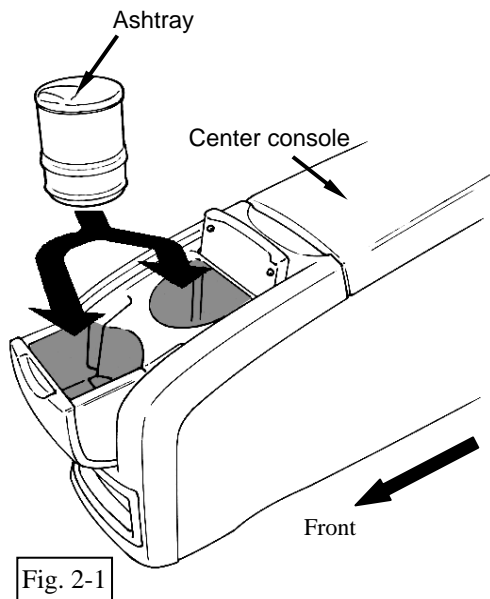
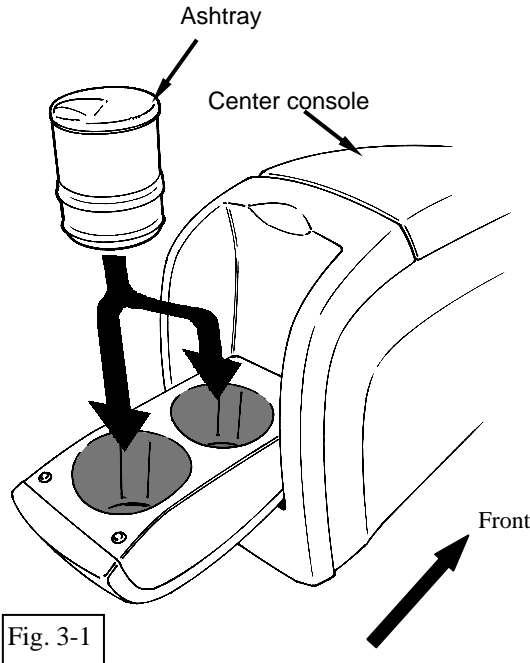

Fig. 2-1

**2. Install the Ashtray (Front Console Cup Holder).**

- (a) Insert the ashtray into the front cup holder of the center console. (Fig. 2-1)

**(1) NOTE: Actual center Console may differ from what is shown.**









### 3. Install the Ashtray (Rear Cup Holder).

- (a) Insert the ashtray into the rear cup holder of the center console. (Fig. 3-1)

**(1) NOTE: Actual center Console may differ from what is shown.**

### 4. Caution.

-  (a) When not using the ashtray, close the door. While driving, a cigarette butt may drop out of the ashtray if it is left open.
-  (b) Make sure to put a cigarette butt into the ashtray after completely stubbing out the lighted cigarette and close the door. Failure to do so may cause a fire in the vehicle.
-  (c) Never put something inflammable such as wastepaper in the ashtray or a fire may be caused in the vehicle.
-  (d) Never drop the ashtray onto hard ground surface or damage may result.
-  (e) Never apply excessive force to the ashtray door when it is open or damage may result.
-  (f) Remove the ashtray slowly. Removing it quickly may cause a cigarette butt drop out of the ashtray.
-  (g) Open and close a vehicle door with the ashtray door closed. A cigarette butt may drop out of the ashtray if it is left open.

Checklist - these points **MUST** be checked to ensure a quality installation.

<u>Check:</u>	<u>Look For:</u>
<p><u>Accessory Function Checks</u></p> <p><input type="checkbox"/> Ash cup</p>	<p>Installed firmly in cup holder.</p>
<p><u>Vehicle Appearance Check</u></p> <p><input type="checkbox"/> After accessory installation and removal of protective cover(s), perform a visual inspection.</p>	<p>Ensure no damage (including scuffs and scratches) was caused during the installation process. (For PPO installations, refer to TMS Accessory Quality Shipping Standard.)</p>